



# VINUR

**Price list**

Extended 27.10.03

up to 31.12.04

(11.02.04)

## sliding cabinets

Wood types:

light/natural birch; alpine/natural ash

LeoLayout



Wackenhut Customer Service

Hotline number +49(0)171/4089000

Mo. - Fr. 12.<sup>00</sup>-13.<sup>15</sup> + 16.<sup>50</sup>-19.<sup>00</sup> hours

Sa. 8.<sup>00</sup>-12.<sup>00</sup> hours

Current product list:

Faxback +49(0)7453/2772301

### List of contents

- |   |          |
|---|----------|
| • Sliding door cabinets                             | p. 1     |
| • Description of sliding door cabinets              | p. 2 + 3 |
| • Top trim piece + lighting (sliding door cabinets) | p. 4     |
| • Internal division                                 | p. 4     |
|   | p. 5 - 7 |

Please complete with beds and chests of drawers from the models

<b>Point</b> <small>plus</small>	natural birch light birch alpine ash
<b>Vista</b>	natural + light birch
<b>ZOOM</b>	natural birch light birch alpine ash
<b>VINUR</b>	natural + light birch, natural + alpine ash

**SLIDING DOOR CABINETS 1**

**Cabinet height including LED trim or decorative trim**

**S22 = 229 cm**  
**S23 = 242 cm**

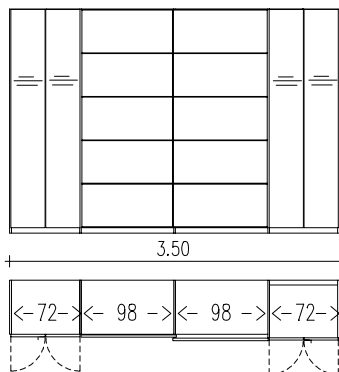
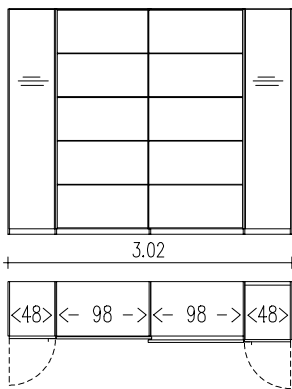
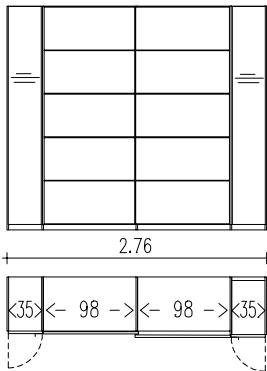
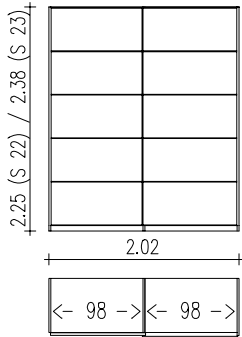

**Order no.**      **birch / ash**

SLK... = LED trim  
SKZ... = decorative trim

**Cabinet with 2 sliding doors**  
standard internal division for each unit:  
2 compartment shelves + 1 rail

**S22 2S 202**  
**S23 2S 202**  
SLK 202  
SKZ 202

**Cabinet with 2 sliding and 2 hinged doors**  
standard internal division for each unit:  
2 compartment shelves + 1 rail

**S22 4X 276**  
**S23 4X 276**  
SLK 276  
SKZ 276

**Cabinet with 2 sliding and 2 hinged doors**  
standard internal division for each unit:  
2 compartment shelves + 1 rail

**S22 4X 302**  
**S23 4X 302**  
SLK 302  
SKZ 302

**Cabinet with 2 sliding and 4 hinged doors**  
standard internal division for each unit:  
2 compartment shelves + 1 rail

Please note:  
Handles on the outside doors  
(symmetrical reason)

**S22 6X 350**  
**S23 6X 350**  
SLK 350  
SKZ 350

**Front variants**

**Surcharge package 1**

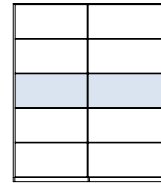

Variant	<b>Order no.</b>
2 x mirrors	<b>SV1 T2</b>
2 x matt glass	<b>SV1 M2</b>
2 x glass terra	<b>SV1 M T</b>
2 x glass rosso	<b>SV1 M R</b>

**Surcharge package 2**

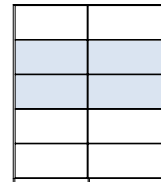

Variant	<b>Order no.</b>
4 x mirrors	<b>SV2 T2</b>
4 x matt glass	<b>SV2 M2</b>
4 x glass terra	<b>SV2 M T</b>
4 x glass rosso	<b>SV2 M R</b>

**Surcharge package 3**

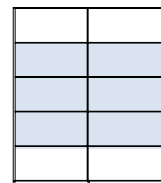

Variant	<b>Order no.</b>
6 x mirrors	<b>SV3 T2</b>
6 x matt glass	<b>SV3 M2</b>
6 x glass terra	<b>SV3 M T</b>
6 x glass rosso	<b>SV3 M R</b>

**Surcharge package 4**

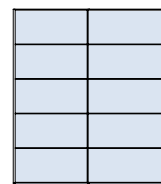

Variant	<b>Order no.</b>
10 x mirrors	<b>SV5 T2</b>
10 x matt glass	<b>SV5 M2</b>
10 x glass terra	<b>SV5 M T</b>
10 x glass rosso	<b>SV5 M R</b>

## sliding cabinets

Wood types:

light/natural birch; alpine/natural ash

## SLIDING DOOR CABINETS 2

**Cabinet height including LED trim or decorative trim**  
**S22 = 229 cm**  
**S23 = 242 cm**

**Order no.** birch / ash

SLK... = LED trim

SKZ... = decorative trim

### Cabinet with 2 sliding doors

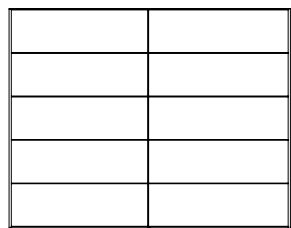
 standard internal division for each unit:  
 2 compartment shelves + 1 rail

2.98

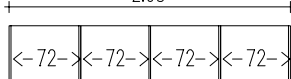
**S22 2S 298**
**S23 2S 298**

SLK 298

SKZ 298

### Cabinet with 2 sliding and 2 hinged doors

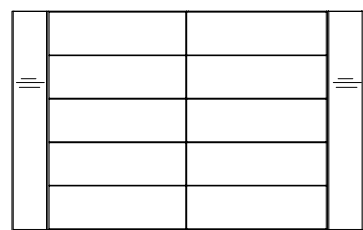
 standard internal division for each unit:  
 2 compartment shelves + 1 rail

3.73

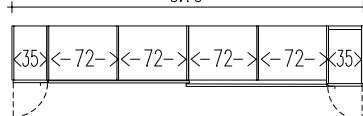
**S22 4X 373**
**S23 4X 373**

SLK 373

SKZ 373

### Cabinet with 2 sliding and 2 hinged doors

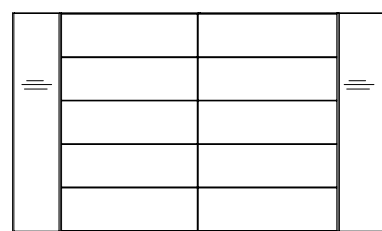
 standard internal division for each unit:  
 2 compartment shelves + 1 rail

3.98

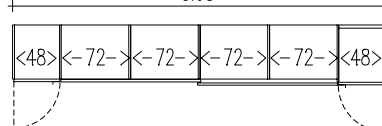

**S22 4X 398**
**S23 4X 398**

SLK 398

SKZ 398

### Front variants

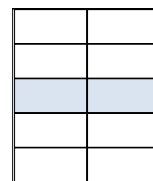
#### Surcharge package 1



Variant

**Order no.**

2 x mirrors

**SV1 T2**

2 x matt glass

**SV1 M2**

2 x glass terra

**SV1 M T**

2 x glass rosso

**SV1 M R**

#### Surcharge package 2

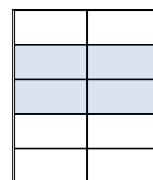

Variant

**Order no.**

4 x mirrors

**SV2 T2**

4 x matt glass

**SV2 M2**

4 x glass terra

**SV2 M T**

4 x glass rosso

**SV2 M R**

#### Surcharge package 3

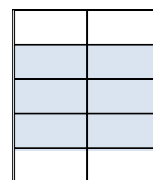

Variant

**Order no.**

6 x mirrors

**SV3 T2**

6 x matt glass

**SV3 M2**

6 x glass terra

**SV3 M T**

6 x glass rosso

**SV3 M R**

#### Surcharge package 4

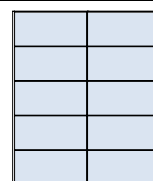

Variant

**Order no.**

10 x mirrors

**SV5 T2**

10 x matt glass

**SV5 M2**

10 x glass terra

**SV5 M T**

10 x glass rosso

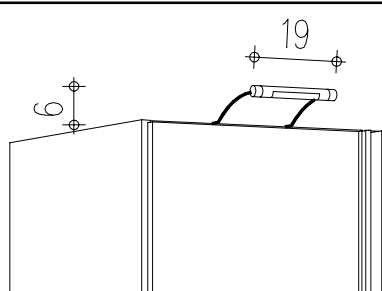
**SV5 M R**

### Cabinet light SL 009

 - for all sliding door cabinets -  
 Description, see p. 4

**Order no.**  
**SL 009**

**SLIDING DOOR CABINET**

**sliding cabinets**

Wood types:  
light/natural birch; alpine/natural ash

LeoLayout

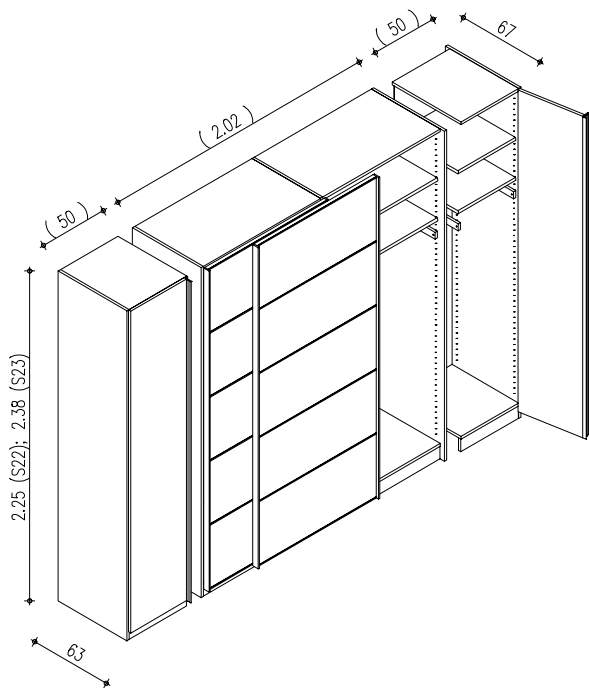

**Description of sliding door range:**

Wardrobe with 2 wide sliding doors, **horizontal grain**, aluminium gripper rails in door length and internal division (2 compartment shelves + 1 clothes rail per unit); partly on the left and on the right with hinged doors;

**Cabinet depth incl. continuous gripper rail:**

**Depth left : 63 cm - right: 67 cm**

**Cabinet height S22: 225 cm**

**Cabinet height S23: 238 cm**

**Necessary room height for the structure:**

	without trim:	incl. trim:
for cabinet height S22:	228 cm	231 cm
for cabinet height S23:	241 cm	244 cm

**Sliding door cabinets are individual cabinets**

**with horizontal grain;**

**and can neither be combined with fitted units nor with hinged and folding door cabinets.**

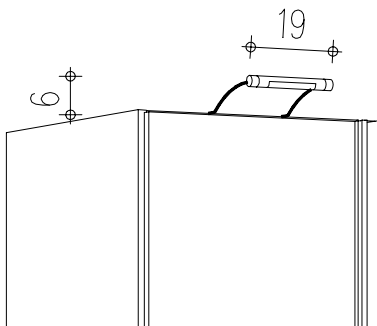

**Cabinet light SL 009**

Footswitches and transformers are included to specific order (number and position is dependent on the cabinet design).

Complete lighting for SL

**Sliding door**

**cabinet height S22 = 225 cm**  
**incl. cabinet light = 231 cm**

**Cabinet height S23 = 238 cm**  
**incl. cabinet light = 244 cm**

**Order no.**  
**SL 009**

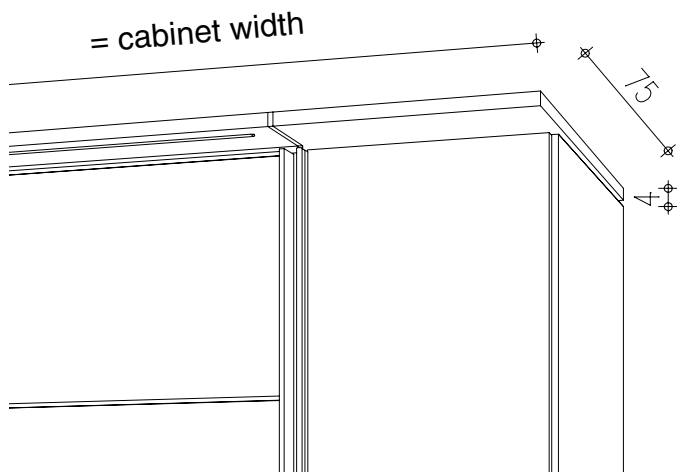

**Description of LED trim + decorative trim**

**Top trim panel** with aluminium-coloured pilaster strips incl. modern **LED light strip** (linear light approx. 180 or 280 cm long)  
**Order no.:** "SLK ..." [under cabinet order no.]

**Top trim panel** with aluminium-coloured pilaster strips without lighting  
**Order no.:** "SKZ ..." [under cabinet order no.]

**Cabinet height incl. trim: S22 = 229 cm**



**Cabinet height incl. trim: S23 = 242 cm**





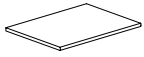

**sliding cabinets**

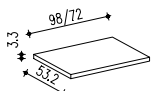
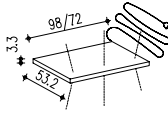
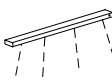
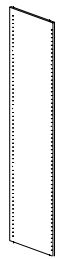
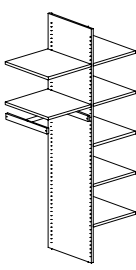
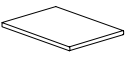
 Wood types:  
 light/natural birch; alpine/natural ash

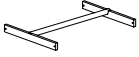
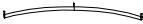
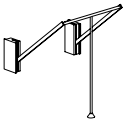
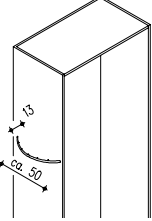
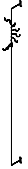
**CABINET INTERNAL DIVISION**

LeoLayout

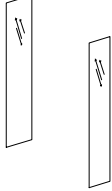
Description	Order no.		<div style="background-color: #ffff00; padding: 2px;">suitable for units with</div>		<div style="background-color: #ffccff; padding: 2px;">sliding doors</div>	<div style="border: 1px solid black; padding: 2px;">x ... possible</div>	Limitations Comments
			hinged doors				
 <b>Compartment shelf</b> SE 35 SE 48 SE 72 SE 98				x			
				x			
				x	x		
				x	x		
 ... for angled cabinet SEA A48 SEE 080  ...for corner cabinet SEE 096 SEE 113				x			
				x			
				x			
				x			
 <b>Glass shelf with aluminium border</b> SEG 72 SEG 98				x	x		
				x	x		
 <b>Glass shelf with integrated illumination switch, and 220V flat plug</b> SEG 72 B SEG 98 B				x	x		
				x	x		
 <b>Cabinet internal light</b> for fitting to cabinet or top shelf; with 220V flat plug + IR light barrier SIL 072 SIL 098				x	x	<b>Please note:</b> Automatic switch off mechanism does not operate behind right-hand sliding doors	
				x	x		
 <b>Central panel</b> <b>MW 22</b> for 225 cm high cabinets <b>MW 22F</b> <b>MW 22X</b> <b>MW 23</b> for 238 cm high cabinets <b>MW 23F</b> <b>MW 23X</b> Addition -X for sliding doors				x			
					x		
					x	x	
					x		
					x	x	
					x	x	
 <b>Lingerie organiser with central panel</b> <b>WM 22 072 =</b> 1 MW 22 + 7 SE 35 + 1 ST 35 for 72 cm intern. dimension <b>WM 23 072 =</b> 1 MW 23 + 7 SE 35 + 1 ST 35 for 72 cm intern. dimension <b>WM 22 098 =</b> 1 MW 22 + 7 SE 48 + 1 ST 48 for 98 cm intern. dimension <b>WM 23 098 =</b> 1 MW 23 + 7 SE 48 + 1 ST 48 for 98 cm intern. dimension Addition -X for sliding doors	<div style="border: 1px solid black; padding: 2px;">instead of standard division</div>			x		Prices are surcharges to the standard internal division; the listed items are supplied instead of the 2 compartment shelves + 1 rail!	
				x			
							x
				x			
				x			
				x			
				x			
				x			
				x			
				x			
				x			
				x			
 <b>Lingerie organiser</b> <b>WE 048 =</b> 5 SE 48 f. fitted unit 50cm <b>WE 048</b> 5 pieces	<div style="border: 1px solid black; padding: 2px;">instead of standard division</div>			x		Price is surcharge to the standard internal division; the listed items are supplied instead of the 2 compartment shelves + 1 rail!	
				x			

Description	Order no.	suitable for units with	hinged doors	sliding doors	Limitations Comments
 <p><b>Clothes rail</b> for mounting in perforated track</p> <p>(without figure) (without figure)</p>	<p><b>ST 35</b> <b>ST 48</b> <b>ST 72</b> <b>ST 98</b> <b>STE 080</b> <b>STE 096</b></p>		<p>x x x x x x</p>	<p>x x</p>	<p>(not suitable or only conditionally suitable for reduced carcass depth)</p>
 <p><b>Clothes rail</b> for corner cabinet E113 (for fitting to compartment)</p>	<p><b>STE 113</b></p>		<p>x</p>		
 <p><b>Wardrobe lift</b></p> <p>additional depth frames (pair)</p> <p>solid wooden distance (on central piece)</p>	<p><b>GL 72</b> <b>GL 98</b> <b>GL DR</b> <b>GL DA</b></p>		<p>x x x</p>	<p>x<sup>1</sup> x<sup>1</sup> x<sup>2</sup></p>	<p>x<sup>1</sup> = „In connection with <b>GL DA</b> on central piece“</p> <p>for 165°-hinges</p> <p>x<sup>2</sup> = „Only for wardrobe lifts in the middle of sliding-door cabinets!“</p>
 <p><b>Clothes cabinet, curved;</b> matt chromed; for mounting to the carcass (outside) Width x depth [cm]: 13 x 50</p>	<p><b>GB 002</b></p>		<p>x</p>	<p>x</p>	
 <p><b>Belt holders</b> rotating, approx. 133 cm high</p>	<p><b>GD 001</b></p>		<p>x</p>	<p>x</p>	
 <p><b>Tie holders</b> rotating, approx. 133 cm high</p>	<p><b>KD 001</b></p>		<p>x</p>	<p>x</p>	
 <p><b>Wardrobe hangers</b> swivelling, approx. 34 cm high</p>	<p><b>GB 001</b></p>		<p>x</p>	<p>x<sup>3</sup></p>	<p>x<sup>3</sup> = „For mounting to the carcass“</p>
 <p><b>Belt and tie holders</b> swivelling, approx. 34 cm high</p>	<p><b>GK 001</b></p>		<p>x</p>	<p>x<sup>3</sup></p>	<p>x<sup>3</sup> = „For mounting to the carcass“</p>
 <p><b>Inside door mirror</b> wide <b>TI 001</b> approx. 135 x 31 cm</p> <p>narrow <b>TI 003</b>  approx. 135 x 21 cm</p>	<p><b>TI 001</b> <b>TI 003</b></p>		<p>x x</p>		

**sliding cabinets**

 Wood types:  
 light/natural birch; alpine/natural ash

**CABINET INTERNAL DIVISION**

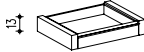
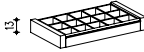
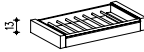
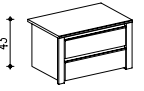
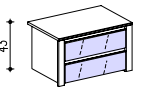
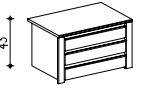
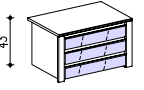
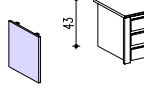
Description	Order no.				Limitations Comments	<div style="border: 1px solid black; padding: 2px;">x ... possible</div>	<div style="border: 1px solid black; padding: 2px;">SI's + SIC's are not suitable for reduced carcass depth!</div>
		suitable for units with hinged doors	hinged doors	sliding doors			
 <b>Cabinet inner base unit</b>	<b>SI 35</b>		x			cannot be fitted in the hinge area!	
	<b>SI 48</b>		x				
	<b>SIV 72</b>		x	x			
	<b>SIV 98</b>		x	x			
 <b>Cabinet inner base unit with division</b> in solid wood 12 compartments for internal dim. 72cm 15 compartments for internal dim. 98cm	<b>SIVE 72</b>		x	x			
	<b>SIVE 98</b>		x	x			
 <b>Cabinet inner base unit for 5 pairs of trousers</b> for hanging for internal dimension 72cm <b>for 7 pairs of trousers</b> for hanging for internal dimension 98cm	<b>SIVH 72</b>		x	x			
	<b>SIVH 98</b>		x	x			
 Cabinet inner drawer container with 2 deep drawers	<b>SIC2-48</b>		x	x <sup>4</sup>	x <sup>4</sup> = „Only in conjunction with additional side SIC ZS“		
	<b>SIC2-72</b>		x	x			
	<b>SIC2-98</b>		x	x			
 Cabinet inner drawer container with 2 deep drawers and glass fronts (opaque)	<b>SIC2-48G</b>		x	x <sup>4</sup>	x <sup>4</sup> = „Only in conjunction with additional side SIC ZS“		
	<b>SIC2-72G</b>		x	x			
	<b>SIC2-98G</b>		x	x			
 Cabinet inner drawer container with 3 shallow drawers	<b>SIC3-48</b>		x	x <sup>4</sup>	x <sup>4</sup> = „Only in conjunction with additional side SIC ZS“		
	<b>SIC3-72</b>		x	x			
	<b>SIC3-98</b>		x	x			
 Cabinet inner drawer container with 3 shallow drawers and glass fronts (opaque)	<b>SIC3-48G</b>		x	x <sup>4</sup>	x <sup>4</sup> = „Only in conjunction with additional side SIC ZS“		
	<b>SIC3-72G</b>		x	x			
	<b>SIC3-98G</b>		x	x			
 can be finished on one side with additional side SIC ZS	<b>SIC ZS</b>		x	x			

**Price list**

Extended 27.10.03

up to 31.12.04

(11.02.04)

**VINUR**

**sliding cabinets**

Wood types:

light/natural birch; alpine/natural ash



**SPACE FOR IDEAS**

LeoLayout